

Measumax  MX

ELECTRONIC CALIPER GAUGE

OPERATION MANUAL

www.measumax.com

1. Functional elements

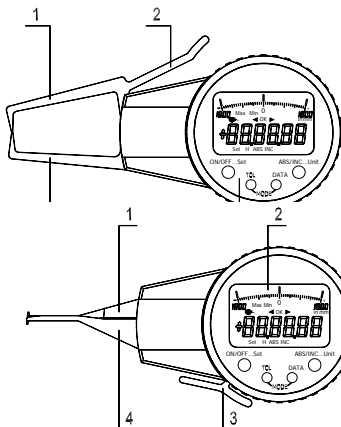

Outside

- (1)、Movable caliper arm
- (2)、Spanner
- (3)、Electronic unit
- (4)、Fixed caliper arm

Inside

- (1)、Movable caliper arm
- (2)、Electronic unit
- (3)、Spanner
- (4)、Fixed caliper arm

2. Electronic unit

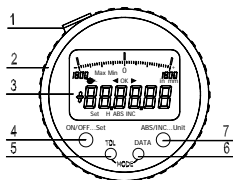

- 1) SPC output
- 2) Cover
- 3) LCD display
- 4) ON/OFF...Set key
- 5) TOL key
- 6) DATA key
- 7) ABS/INC...Unit key
- 5+6) MODE key

3. LCD display

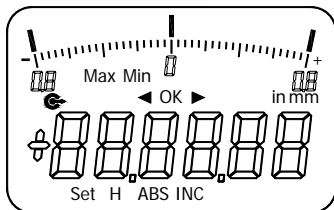



- Min: Hold minimum value automatically
- Max: Hold maximum value automatically
- ⊖: Data output
- H: Hold determined value automatically
- ⊕: Data greater than zero
- : Data smaller than zero
- ▶: Set upper limit or data greater than upper limit
- ◀: Set lower limit or data smaller than lower limit
- OK: The workpiece is in the scale of tolerance
- ▣: Analog display graduation range
- in: Inch measuring mode
- mm: Metric measuring mode
- ABS: Absolute measuring mode
- INC: Relative measuring mode
- Set: Origin set

4. Operation

4.1 ON/OFF...Set key

Two ways of pressing key are used in the following illustration:

- (1)  Press and release;
 - (2)  Press and hold (more than 2 sec.).
- Press and release (less than 2 sec.): Power on/off.
 - Press and hold (more than 2 sec.): Setting origin data, and "Set" sign starts blinking.
- a. When no need to reset, press and release the [ON/OFF...Set] key (less than 2 sec.) to enter measuring mode.
 - b. When need to reset, press and hold the [ON/OFF...Set] key (more than 2 sec.) until next digit starts blinking. Press and release the key again, the figure increases by 1. Repeat the above procedure until a desired digit is displayed. The settings of digit from the second digit to the sixth digit are the same as those of the first digit. When "Set" sign starts blinking again, perform the step a to enter

sign starts blinking. Press and hold the [TOL] key or the [ABS/INC...Unit] key (more than 2 sec.), the “+” sign and each digit blinks in turn. When a desired sign or digit starts blinking, press and release the [TOL] key (less than 2 sec.) once, the sign switches once or the digit increases by 1. Repeat the above procedure until the desired data is set. Press and release the [TOL] key (less than 2 sec.) to enter lower limit setting with the “◀” sign blinking.

- Lower limit setting: The setting of the sign and digits of lower limit is the same as that of upper limit. When the “◀” sign starts blinking again, press and release the [TOL] key (less than 2 sec.) to enter measuring mode.
- During the tolerance set, press the [DATA] key to quit the setting, and press the [ABS/INC...Unit] key to switch the units quickly.
- The upper limit must be greater than the lower limit. Otherwise “E 4” sign is displayed, press any key to start setting the tolerance again.
- The tolerance limit must be less than 5000mm. Otherwise “E 2” sign is displayed, press any key to start setting the tolerance limit again.

Example: Upper limit +0.2 Lower limit -0.1

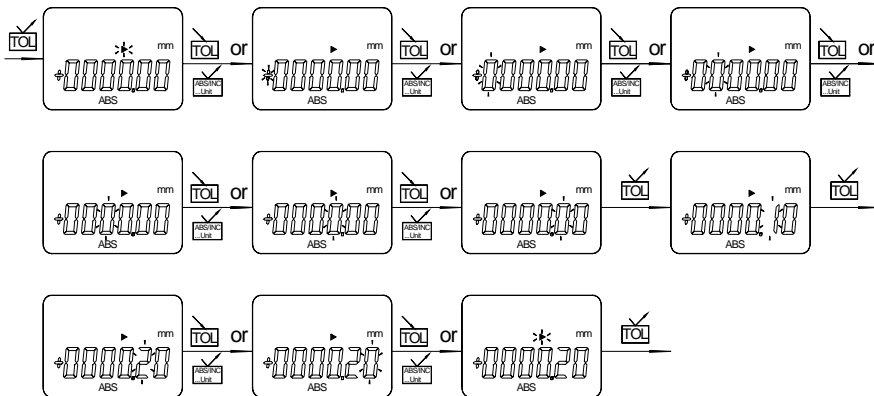

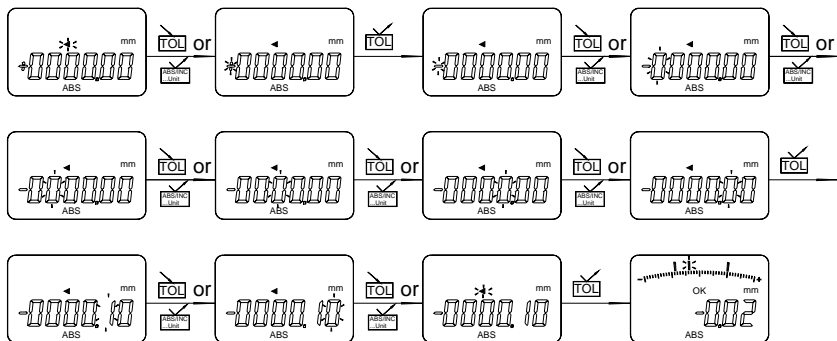

4.4 DATA key

- Data output key. The method of operation refers to the section 10.

4.5 MODE key

The instrument has 4 modes. Press [TOL] key and [DATA] key simultaneously: The measuring mode is changed, and the sign “Min”, “Max”, “H” and non-measurement mode display on LCD in turn.

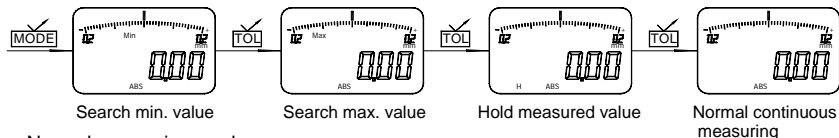

a. Normal measuring mode

Displaying value is identical with relative position of the caliper when non-measurement mode appears.

b. Hold minimum value automatically

“Min” sign displays on LCD in this mode. “Min” sign starts blinking when moving the movable caliper quickly. “Min” sign stops blinking on LCD after the calipers are in contact with workpiece and hold 1 sec.. The instrument remembers the value. “Min” sign starts blinking again when moving the movable caliper slowly. “Min” sign stops blinking on LCD after hold 1 sec.. And the instrument remembers and displays minimum value of held value. The instrument will repeat the above process when moving the movable caliper quickly. The instrument displays minimum value after the movable caliper returns to its home position.

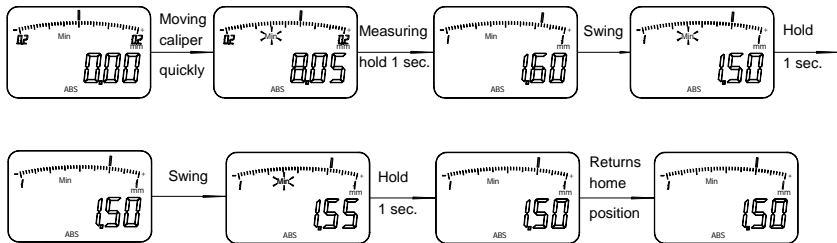

Display min. value remembered

Electronic caliper gauge for outside measurement:

Measuring wall thickness or external diameter is in “Min” mode. Steadily pivot gauge vertically until find minimum value in an axle plane.



Electronic caliper gauge for inside measurement:

Measuring bore diameter is in “Min” mode. Steadily pivot gauge vertically until find minimum value in an axle plane.



- Setting origin data is in “Min” mode. And it is more convenience.

Measuring setting block or setting ring is in “Min” mode. Take out setting block or setting ring after finding and remembering minimum value. Input value of the setting block or setting ring after the movable caliper returns to its home position (See item 4.1).

c. Hold maximum value automatically

“Max” sign displays on LCD in this mode. “Max” sign starts blinking when moving the movable caliper quickly. “Max” sign stops blinking on LCD after the calipers are in contact with workpiece and hold 1 sec.. The instrument remembers the value. “Max” sign starts blinking again when moving the movable caliper slowly. “Max” sign stops blinking on LCD after hold 1 sec.. And the instrument remembers and displays maximum value of held value. The instrument will repeat the above process when moving the movable caliper quickly. The instrument displays maximum value after the movable caliper returns to its home position.

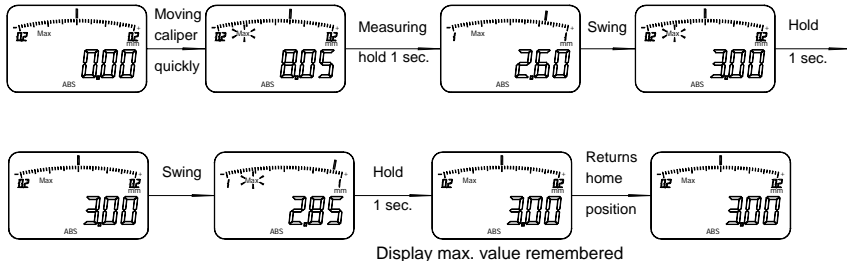

Electronic caliper gauge for outside measurement:

Measuring external groove diameter (narrow grooves) is in “Max” mode. Move gauge horizontally back and forth until find maximum value in a diameter plane.

Electronic caliper gauge for inside measurement:

Measuring internal groove diameter is in “Max” mode. Move gauge horizontally back and forth until find maximum value in a diameter plane.

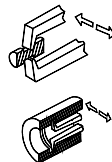

d. Hold determined value automatically

The instrument will hold determined value if the movable caliper is still and the instrument is in “H” mode. “H” sign starts blinking when moving the movable caliper. Hold gauge steadily until measured value appears after around 2 sec., and “H” sign stops blinking. And the instrument remembers and holds the value.

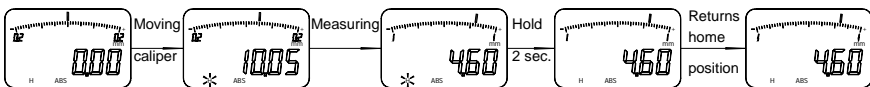

5. Analog display

5.1 Analog display in normal measuring mode: switch over range automatically.

Analog display range		Digital display range (Fractional part)		Analog display resolution	
mm	in	mm	in	mm	in
± 0.2	± 0.01	X.00—X.19	X.0000—X.0099	0.01	0.0005
± 0.4	± 0.02	X.20—X.39	X.0100—X.0199	0.02	0.001
± 1	± 0.1	X.40—X.99	X.0200—X.0999	0.05	0.005
	± 0.2		X.1000—X.1999		0.01
	± 1		X.2000—X.9999		0.05

Sample fig.

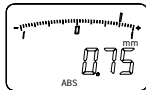
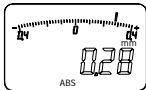
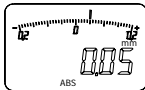

5.2 Analog display in tolerance measuring mode

The method of tolerance setting refers to the section 4.3.

In measuring mode, the two non-blinking bars are the limits of the tolerance range, and the other blinking bar is the measuring data of workpiece.

- The bar starts blinking in the tolerance range when workpiece is qualified. See fig. 5.2a.
- The bar starts blinking outside the tolerance range when the tolerance of workpiece is beyond tolerance range. See fig. 5.2b and 5.2c.
- A bigger blinking bar displays outside the range when the tolerance of workpiece is beyond the analog display range. See fig. 5.2d and 5.2e.

Example: Upper limit +0.5

Lower limit 0

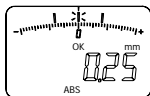

Qualified

Fig. 5.2a

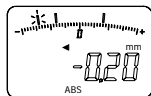

Smaller than
lower limit

Fig. 5.2b

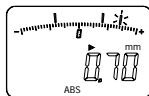

Greater than
upper limit

Fig. 5.2c

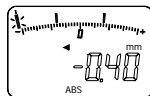

Lower limit
smaller than
analog display range
Fig. 5.2d

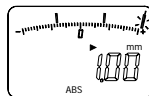

Upper limit
greater than
analog display range
Fig. 5.2e

6. Use

Suited for relative measuring internal or external dimensions.

7. Setting origin data

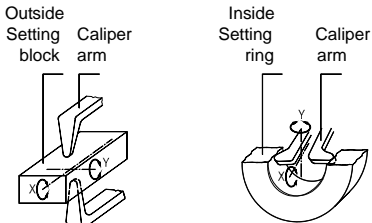

Setting zero position before measuring. Clean measuring faces of setting block, setting ring and faces of caliper arms with soft cloth (Electronic caliper gauge for inside measurement can be set zero position with corresponding measuring range's outside micrometer.). Put the instrument into the setting block or setting ring by moving spanner. Make measuring points of the caliper arms and setting measuring faces contact by loosening spanner. Moving caliper arm. Rotate electronic caliper gauge for outside measurement along axis X and axis Y until the instrument determines the minimum value. Rotate electronic caliper gauge for inside measurement along axis X until the instrument determines the maximum value. Then keep direction of axis X unchanged, rotate along axis Y until the instrument determines the minimum value. Make indicator value identical with the

setting block or the setting ring. Repeat the above process until zero position stops changing.

8. Features

Repeatability: 0.01mm

Maximum Measuring force: 4N. Range is in 0.4N.

Double displays: Digit and graduation displays

Resolution: 0.01mm/0.0005in

Responding speed: 0.35m/s

Power consumption: $\leq 50 \mu A$

Operating temperature: 0 ~ 40°C

Storage temperature: -20 ~ 60°C

9. Power

- Use one CR2032 battery. Replace the battery when display data is blurring on LCD.
- When replace battery, remove the battery cap with a screwdriver and pull it out. Take out the worn battery and put a new one in according to the polarity marked on the cap.



- If not used in about 5 minutes, the power will auto-off. The instrument will wake up when pressing [ON/OFF...Set] key or moving caliper arm.
- Power off the instrument by pressing [ON/OFF...Set] key to save battery if not use.

10. Data output

- Data output interface is RS232C.
- The instrument can be connected to PC's serial port by SPC cable (Order No. P1103 or P1104) or to PC's USB port by SPC cable and USB to serial port cable (Order No. P1201).
- Remove the rubber cap of the output connector with a small screwdriver and insert cable plug into the output connector.
- The instrument outputs data once if press the [DATA] key shortly, and the "Ⓢ" sign is displayed on LCD once.
- Press and hold the key (more than 1 sec.), the instrument outputs data continuously and the "Ⓢ" sign keeps displaying on LCD. Press the key again shortly to stop outputting.

10.1 Series port format:

Baud rate	1200	Stop bit	2
Start bit	1	Parity	none
Data bit	7	Data logic	reverse

10.2 Data output format:

Order	1	2	3	4	5	6	7	8	9	10
Metric	S	N1	N1	N	.	N	N	N	CR	LF
Inch	S	N	.	N	N	N	N	N	CR	LF

S: Minus or space

N1: Minus or space or digit 0-9

N: Digit 0-9

11. Precautions

- Do not subject the instrument to blows or knocks.
- Do not drop it or apply excessive force to it.
- Do not disassemble the instrument.
- Do not press the key with a pointed object. Press the key along its moving direction, otherwise it will affect the key's sensitivity.
- Do not use or store the instrument under direct sunlight, or in an excessively hot or cold place.
- Do not subject the instrument to strong magnetic fields and high voltage.
- Use a soft cloth or a cotton swab that is dry to wipe stains off the instrument. Do not use organic solvent such as acetone and benzene.
- Remove the battery if the instrument not used for an extended period of time.

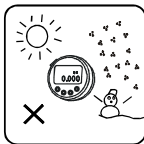

12. Trouble shooting

Failure	Causes	Repairing
Display “ E 1 ” on LCD.	Measuring data over display range.	Deduce the preset data or convert into relative measuring mode.
Display “ E 2 ” on LCD.	Origin data more than 5000mm.	Press any key to preset again.
Display “ E 3 ” on LCD.	1. Sensor overflow. 2. Something wrong with sensor.	1. Reset battery. 2. Return the instrument for repair.
Display “ E 4 ” on LCD.	Upper limit smaller than lower limit.	Press any key to preset again.
Measuring data is not correct.	1. Dirty measuring surfaces. 2. Preset data isn't correct.	1. Clean measuring surfaces. 2. Inspect preset data and reset it.
No display on LCD.	1. Battery voltage under 2.8V. 2. Battery is not properly set.	1. Replace battery. 2. Reset battery.
Display is confusing or display remains dead.	Battery is not properly set.	Reset battery.
1. Display blurring. 2. The output data is wrong.	Battery voltage under 2.8V.	Replace battery.